

# .250" (6.35mm) Pitch Power Connectors

## 63501W-N Series

### Vertical Header

inches  
mm

- 2 – 15 circuits available
- Material: UL 94V-2 nylon 66
- Mates with 63501HM-N housing
- Standard color: Nature

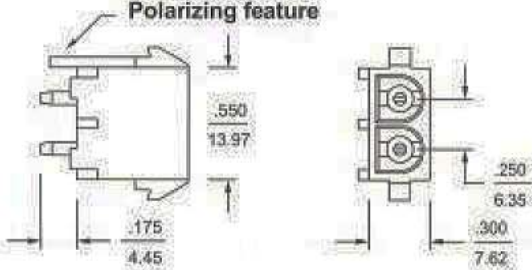
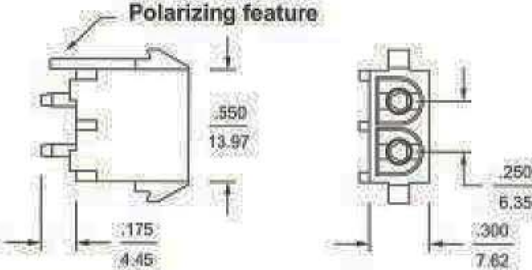
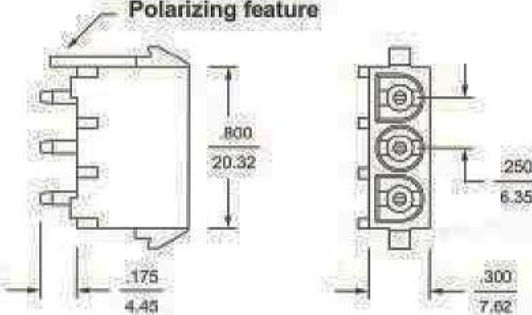
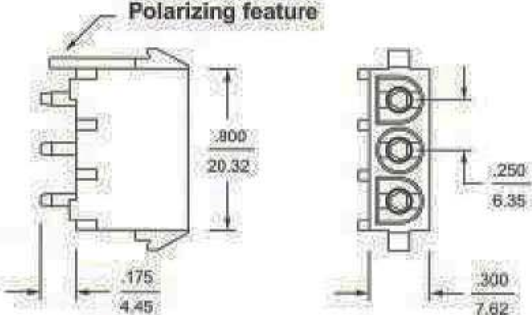
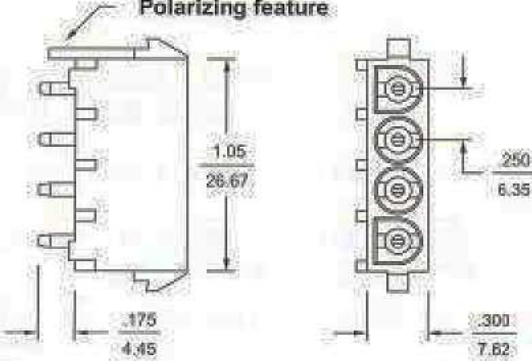
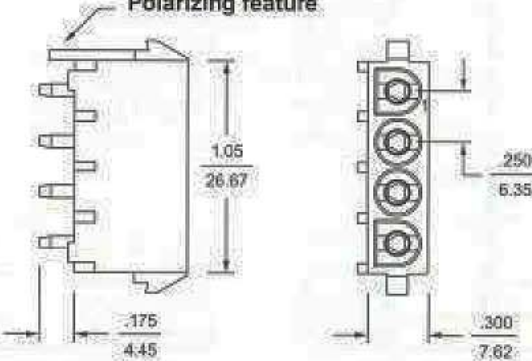
Circuits	Dimensional Information	
	With Male Pins	With Female Pins
2	<p><b>63501WSMP-02 (with Polarizing feature)</b> <b>63501WSM-02 (without Polarizing feature)</b></p> 	<p><b>63501WSFP-02 (with Polarizing feature)</b> <b>63501WSF-02 (without Polarizing feature)</b></p> 
	<p><b>63501WSMP-03 (with Polarizing feature)</b> <b>63501WSM-03 (without Polarizing feature)</b></p> 	<p><b>63501WSFP-03 (with Polarizing feature)</b> <b>63501WSF-03 (without Polarizing feature)</b></p> 
4	<p><b>63501WSMP-04 (with Polarizing feature)</b> <b>63501WSM-04 (without Polarizing feature)</b></p> 	<p><b>63501WSFP-04 (with Polarizing feature)</b> <b>63501WSF-04 (without Polarizing feature)</b></p> 

# .250"(6.35mm) Pitch Power Connectors

Circuits	Dimensional Information	
	With Male Pins	With Female Pins
5	<p>63501WSMP-05 (with Polarizing feature) 63501WSM-05 (without Polarizing feature)</p>	<p>63501WSFP-05 (with Polarizing feature) 63501WSF-05 (without Polarizing feature)</p>
	<p>63501WSMP-06-S (with Polarizing feature) 63501WSM-06-S (without Polarizing feature)</p>	<p>63501WSFP-06-S (with Polarizing feature) 63501WSF-06-S (without Polarizing feature)</p>
6	<p>63501WSMP-06 (with Polarizing feature) 63501WSM-06 (without Polarizing feature)</p>	<p>63501WSFP-06 (with Polarizing feature) 63501WSF-06 (without Polarizing feature)</p>

# .250"(6.35mm) Pitch Power Connectors

Circuits	Dimensional Information	
	With Male Pins	With Female Pins
7	<p>63501WSMP-07 (with Polarizing feature) 63501WSM-07 (without Polarizing feature)</p>	<p>63501WSP-07 (with Polarizing feature) 63501WSF-07 (without Polarizing feature)</p>
	<p>63501WSMP-08 (with Polarizing feature) 63501WSM-08 (without Polarizing feature)</p>	<p>63501WSP-08 (with Polarizing feature) 63501WSF-08 (without Polarizing feature)</p>

# .250"(6.35mm) Pitch Power Connectors

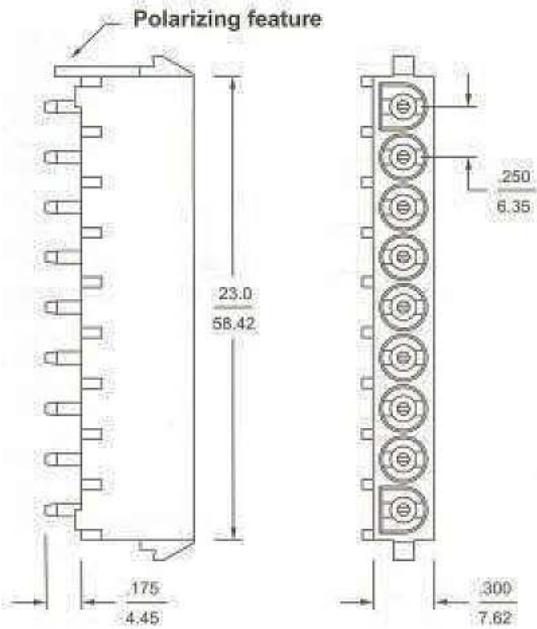
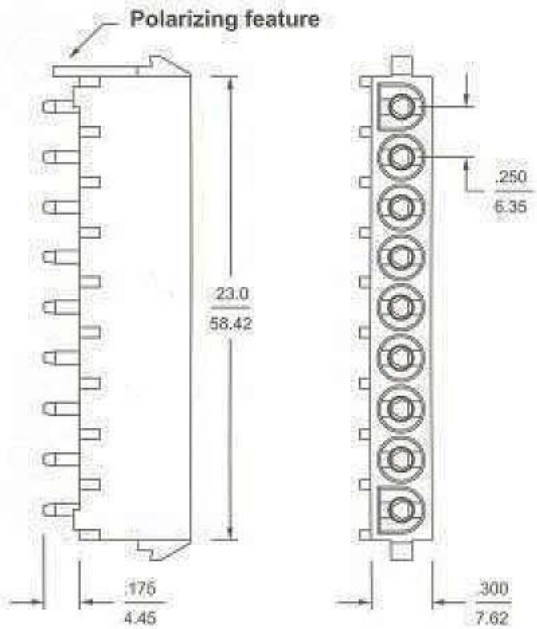
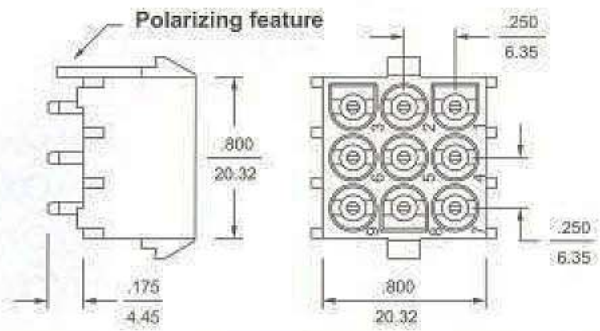
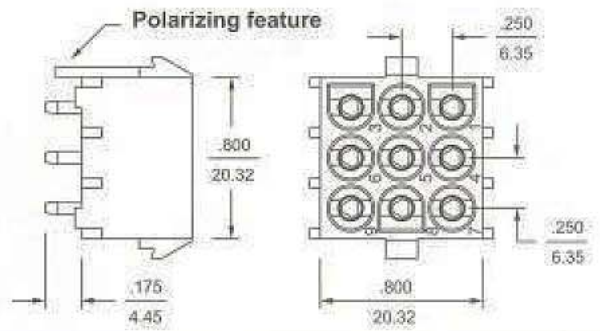
Circuits	Dimensional Information	
	With Male Pins	With Female Pins
9	<p>63501WSMP-09-S (with Polarizing feature) 63501WSM-09-S (without Polarizing feature)</p> 	<p>63501WSFP-09-S (with Polarizing feature) 63501WSF-09-S (without Polarizing feature)</p> 
9	<p>63501WSMP-09 (with Polarizing feature) 63501WSM-09 (without Polarizing feature)</p> 	<p>63501WSFP-09 (with Polarizing feature) 63501WSF-09 (without Polarizing feature)</p> 

# .250" (6.35mm) Pitch Power Connectors

Circuits	Dimensional Information	
	With Male Pins	With Female Pins
10	<p>63501WSMP-10 (with Polarizing feature) 63501WSM-10 (without Polarizing feature)</p>	<p>63501WSEF-10 (with Polarizing feature) 63501WSE-10 (without Polarizing feature)</p>
	<p>63501WSMP-12 (with Polarizing feature) 63501WSM-12 (without Polarizing feature)</p>	<p>63501WSEF-12 (with Polarizing feature) 63501WSE-12 (without Polarizing feature)</p>

# .250"(6.35mm) Pitch Power Connectors

Circuits	Dimensional Information	
	With Male Pins	With Female Pins
15	<p>63501WSMP-15 63501WSM-15 (Without Polarizing feature)</p>	<p>63501WSFP-15 63501WSF-15 (Without Polarizing feature)</p>

2 ~ 10 circuits:

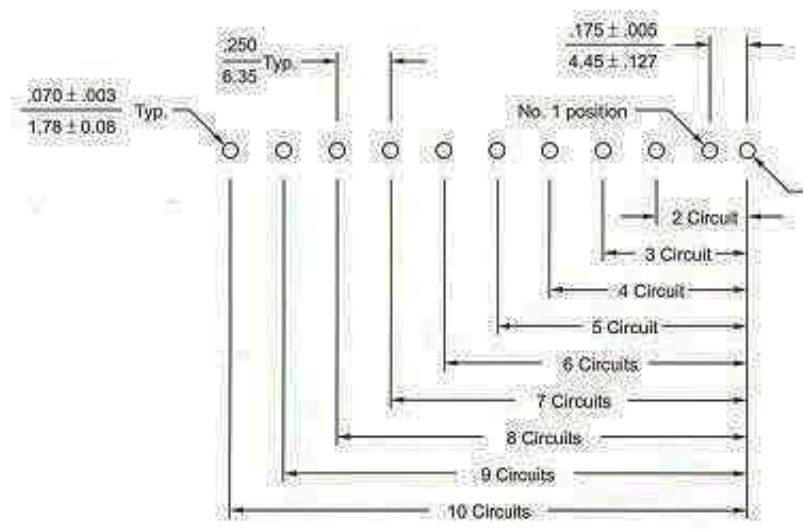

6 ~ 15 circuits:

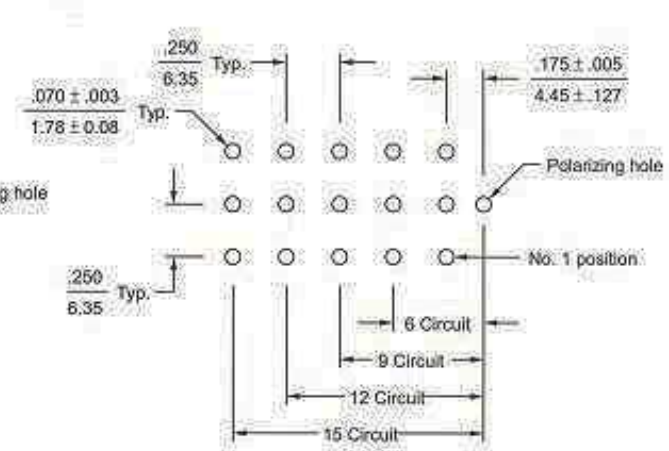

P.C. board hole dimensions