

RoHS

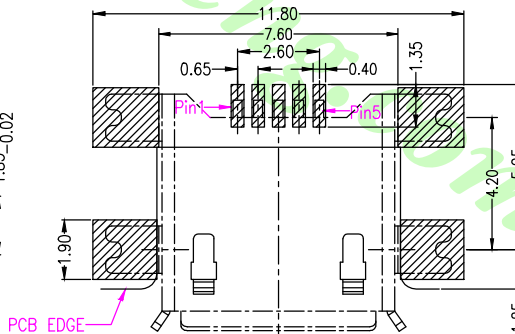
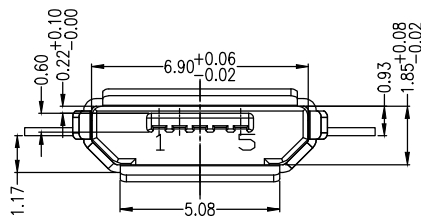
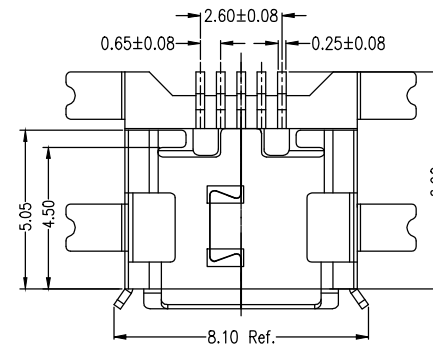
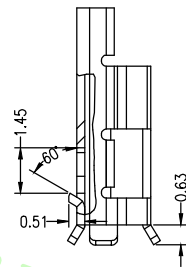
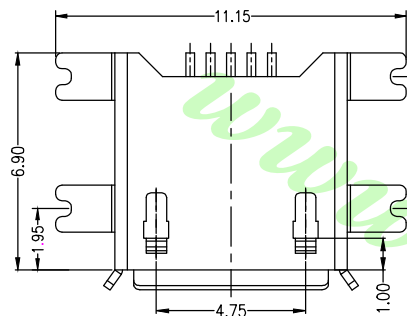
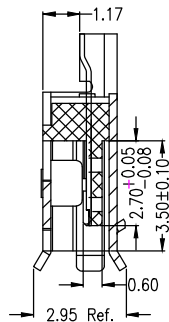
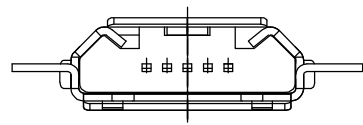

RECOMMENDED PCB LAYOUT

MATERIALS

HOUSING: HI-TEMP. PLASTIC (UL 94V-0)  
SHELL: COPPER ALLOY, TIN PLATING  
TERMINAL: COPPER ALLOY, GOLD PLATED

SPECIFICATION

CURRENT RATING: 1 AMP MAX  
DIELECTRIC WITHSTANDING: 100V AC FOR ONE MINUTE  
CONTACT RESISTANCE: 30m OHMS MAX  
INSULATION RESISTANCE: 100M OHMS MIN AT DC 500V  
OPERATION TEMPERATURE: -25°C~+105°C

PART NUMBER

LMCUB-22TCH 0 5 1 A 1 2 0 7 L

SERIES

NO. OF POS.

CONTACT PLATED OPTION

1: GOLD FLASH

PACKAGE OPTION

2: TAPE REEL

Au PLATING ON SOLDER TAIL

REV	NEW DRAWING	2018.09.25
REV	概述/REVISION	日期/DATE

公差/UNLESS OTHERWISE SPECIFIED TOLERANCES ARE  
.X ±0.30  
.XX ±0.20  
.XXX ±0.10  
ANG. ±3°

單位/Unit mm  
比例/Scale Free  
Size A4

品名/Title : MICRO USB B TYPE, PCB MOUNT, SMT, BOARD CUT TYPE, METAL SHIELD, FEMALE  
料號/Part No : LMCUB-22TCH051A1207L  
圖號/Drawing No : 22TC-043



鍊亨電子有限公司  
LAI HENG TECHNOLOGY LTD.  
TEL: (02) 8228-6487 FAX: (02) 8228-6486

核加/APPD. 7/0 審核/CHKD. Joe 製圖/DR. Mandy 張數/Sheet 1 of 1 REV. A0