

SPECIFICATION

MATERIAL

See drawing

STANDARD DATA

Rating current: 3.0 A

ELECTRICAL

Insulator resistance: 100Mohms Min.

Withstanding voltage: 100 VAC / minute

Contact resistance: 40mohms Max.

MECHANICAL

Mating force: 5~20N Max.

Unmating force : 6~20N Min.

Durability: 10,000 cycles Min.

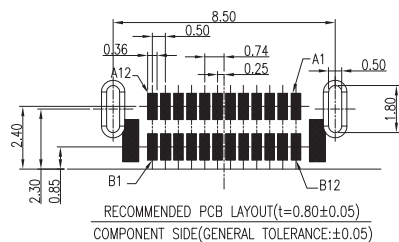
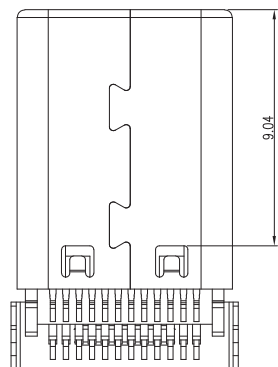
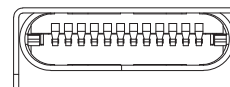
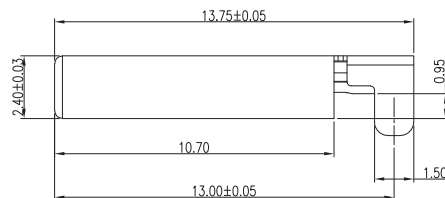
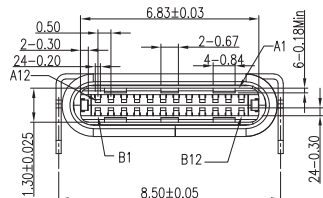

A1	GND	B12	GND
A2	SSTXP1	B11	SSRXP1
A3	SSTXN1	B10	SSRXN1
A4	VBUS	B9	VBUS
A5	CC1	B8	SBU2
A6	DP1	B7	DN2
A7	DN1	B6	DP2
A8	SBU1	B5	CC2
A9	VBUS	B4	VBUS
A10	SSRXN2	B3	SSTXN2
A11	SSRXP2	B2	SSTXP2
A12	GND	B1	GND
PIN	SIGNAL NAME	PIN	SIGNAL NAME

凱帛企業有限公司
KABO ENTERPRISE CO., LTD.

DESCRIPTION(內容)

USB C公TYPE SMT R/A 雙排 24PIN
鉚合式 沉板0.95 鍍金G/F

PART NO:
(料號) USB-C-1042-2493N

DWG NO(圖號):

DRAWN(製圖)

CHECKED(確認):

APPROVAL(核准):

GENERAL TOLERANCE:
(公差)

X	±0.30	X'	±5'
.X	±0.25	.X'	±2'
.XX	±0.30	.XX'	±1'
.XXX	±0.15	.XXX'	±0.5'

SCALE(比例):
1:XX



REV:
A

UNIT:
mm

SIZE:
A4

SHEET:
1/1

REV

1

2

3

4

DESCRIPTION

DATE

2021.01.27

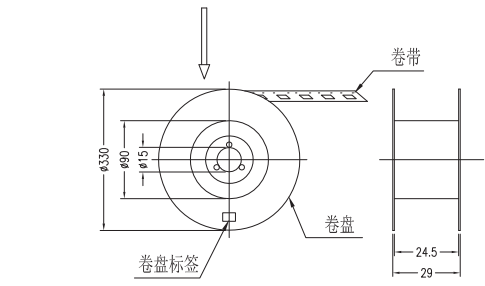
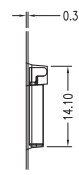
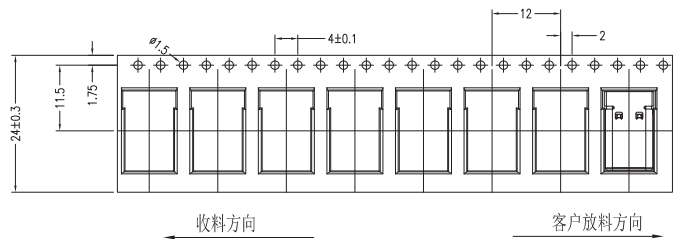

NOTES:

1. 包装数量: 15KPCS箱/10卷/1500PCS/; 当订单量和尾数不足15KPCS时可以合理选择纸箱规格.
2. 纸箱封盖后以封箱胶封箱, 并于侧面贴上出货标签;
3. 外箱规格: 35*35*33.5cm;
卷盘规格: $\phi 330*29$ mm;

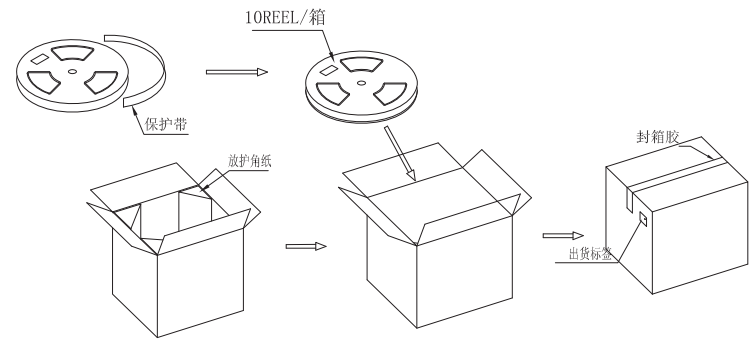
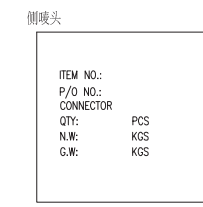
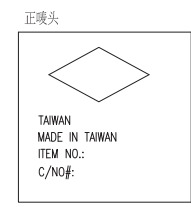

4	护角	4	PCS
3	出货标签	1	PCS
2	外纸箱	1	PCS
1	卷盘	10	SET
序号	包装名称	数量	单位

凱帛企業有限公司
KABO ENTERPRISE CO., LTD.

DESCRIPTION(內容)
USB C公 TYPE SMT R/A 雙排 24PIN
鉤合式 沉板0.95 鍍金G/F
PART NO:
(料 號) **USB-C-1042-2493N**
DWG NO(圖號):

DRAWN(製圖)
CHECKED(確認):
APPROVAL(核准):

GENERAL TOLERANCE:
(公差)

.X	±0.30	.X'	±5°
.X	±0.25	.X'	±2°
.XX	±0.30	.XX'	±1°
.XXX	±0.15	.XXX'	±0.5°

SCALE(比例):
1:XX

REV:	REV	DESCRIPTION	DATE
A	1		2021.01.27
UNIT:	2		
mm	3		
SIZE:	4		
A4			
SHEET			
1/1			