

### Specifications

Current Rating	:3 Amps
Insulator Resistance	:5000 Megohms Min.
Dielectric Withstanding	:AC 1000 V
Operating Temperature	:-40°C ~ +105°C
Contact Material	:Copper Alloy
Insulator Material	:Polyester, UL 94V-0
Standard	:P. B. T
Finish	:Gold Flash all over
Color	:Black

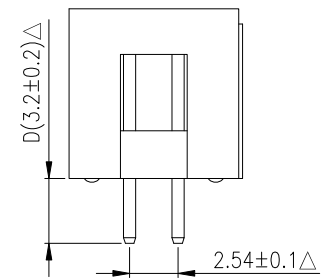

Part No.	A	B	C
CHEB254S006	5.08	12.92	15.24
CHEB254S008	7.62	15.46	17.78
CHEB254S010	10.16	18.00	20.32
CHEB254S012	12.70	20.54	22.86
CHEB254S014	15.24	23.08	25.40
CHEB254S016	17.78	25.90	27.94
CHEB254S020	22.86	30.70	33.02
CHEB254S024	27.94	35.78	38.10
CHEB254S026	30.48	38.32	40.64
CHEB254S030	35.56	43.40	45.72
CHEB254S034	40.64	48.48	50.80
CHEB254S040	48.26	56.10	58.42
CHEB254S042	50.80	58.64	60.96
CHEB254S044	53.34	61.18	63.50
CHEB254S050	60.96	68.80	71.12
CHEB254S060	73.66	81.50	83.82
CHEB254S064	78.74	86.58	88.90

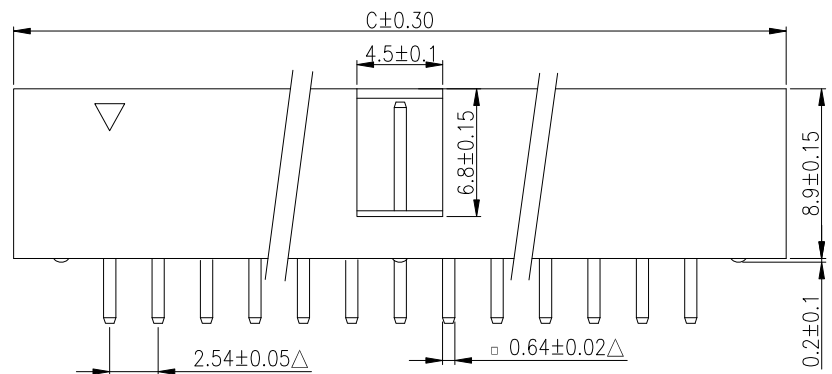

DESCRIPTION(内容):  
**2.54mm BOX HEADER H:9.1 W:9.1**  
**180°□=0.64 (RoHS)**

PART NO:  
 (料 號) **CHEB254S0XX**

DWG NO(圖號):

DRAWN(製圖):  
 黃炳秋

CHECKED(確認):  
 黃炳秋

APPROVAL(核准):  
 鄧文廣

GENERAL TOLERANCE:  
 (公差)

.X	.XXXX
.XX	.X°
.XXX	.XX°

SCALE(比例):  
 1:XX

REV:	REV	DESCRIPTION	DATE
A/5			
UNIT:	2	舊料號:CCHEB254S0XX	2006.04.08
mm	3	舊料號:B210-XXSGP-D032	2006.07.07
SIZE:	4	變更料號(原:CHEB254S0XX-CF438)	2016.08.05
A4	5	修改2X8PIN尺寸	2018.01.24
SHEET:			
1/2			

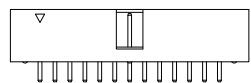

(產品)

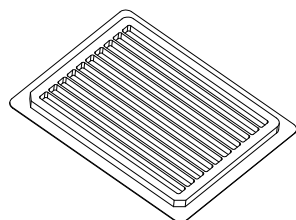
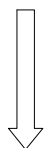

(真空盤)

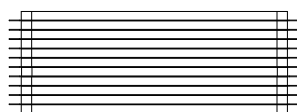
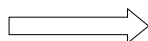

(25盤產品)

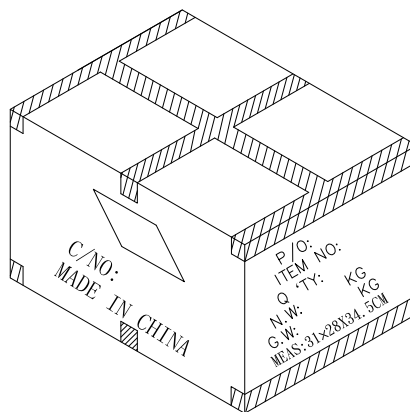

(25盤產品裝一箱)



組規格:310X280X345mm

PIN數	每盤數量	每組數量
2X03	360PCS	9000PCS
2X04	300PCS	7500PCS
2X05	260PCS	6500PCS
2X06	240PCS	6000PCS
2X07	200PCS	5000PCS
2X08	180PCS	4500PCS
2X10	160PCS	4000PCS
2X12	140PCS	3500PCS
2X13	120PCS	3000PCS
2X15	120PCS	3000PCS
2X17	100PCS	2500PCS
2X20	80PCS	2000PCS
2X21	80PCS	2000PCS
2X22	80PCS	2000PCS
2X25	60PCS	1500PCS
2X30	60PCS	1500PCS
2X32	60PCS	1500PCS



DESCRIPTION(內容)  
**2.54mm BOX HEADER H:9.1 W:9.1**  
 180°□=0.64 (RoHS)

PART NO:  
 (料號) **CHEB254S0XX(包裝圖)**

DWG NO(圖號):

DRAWN(製圖):  
 GONG

CHECKED(確認):  
 TERESA

APPROVAL(核准):  
 JOHNNY

GENERAL TOLERANCE:  
 (公差)

.X .XXXX  
 .XX .X°  
 .XXX .XX°

SCALE(比例):  
 1:XX

REV: **A/2**

UNIT:  
**mm**

SIZE: **A4**

SHEET: **2/2**

REV	DESCRIPTION	DATE
1		2016.07.18
2	變更料號(原:CHEB254S0XX-CF438)	2016.07.18
3		
4		